

2016 Best Practices Glass is a companion book to  
BIRD-FRIENDLY DEVELOPMENT GUIDELINES



# BIRD-FRIENDLY DEVELOPMENT GUIDELINES

## Best Practices Glass

The City of Toronto would like to thank the following for their assistance in developing the Bird-Friendly Best Practices • Glass:

John Robert Carley, Architect Incorporated  
Fatal Light Awareness Program (FLAP Canada)  
Daniel Klem Jr., Professor,  
Department of Biology Muhlenberg College, Allentown, Pennsylvania  
Alison Lapp  
Bailey Bradshaw  
Hannah del Rosario  
Joseph Hong  
Photographs and artwork used with permission.

Illustrations and photographs provided by:  
Gabriel Guillen; John Robert Carley, Architect Incorporated;  
Fatal Light Awareness Program (FLAP Canada); Barry Kent MacKay;  
Alison Lapp; Hannah del Rosario; Daniel Woolfson; Tim Hoeflich;  
Karen Jiang; Alan Filipuzzi, Carol L. Edwards  
Front cover: Toronto waterfront illustration by Monika Hoxha  
Bird Layout by FLAP Canada

[www.toronto.ca/planning](http://www.toronto.ca/planning)

Copyright © July 2016, City of Toronto  
Published by: City of Toronto, City Planning

2 Bird-Friendly Best Practices **Glass**



The goal of this document is to inspire, suggest, and direct designers towards treatments of glass to render it as Bird-Friendly as possible. . .to mitigate and prevent deaths of birds.



Photo: "Deadfall" - Mark Thiessen, National Geographic Photographer

# Table of Contents

## Acknowledgements

### Introduction

- 08 What is the Problem? Dead Birds
- 09 Leadership in Bird-Friendly Design
- 10 Why a Best Practices Manual?
- 11 Ontario Legal Context

### The Cause: Light and Glass

- 14 Light and Glass
- 15 Why is the Problem Getting Worse?

### The Problem: Glass

- 18 Properties of Glass
- 19 Building Features that Impact Bird Collisions

### The Solution: Bird-Friendly Building Design

- 24 Building Envelope
  - Design to Eliminate Fly-Through Conditions
- 25 Awnings and Overhangs
  - Exterior Screens, Grilles, Shutters and Sunshades
- 26 Creating Visual Markers
- 29 Opaque and Translucent Glass
  - UV Glass (or similar products)
  - Low Reflectance Glass
- 30 Ineffective Strategies

### Applying Bird-Friendly Building Design to New Development in Toronto:

- 34 Toronto Green Standard
- 37 Compliance Strategies (TGS Tier 1)

### Appendix

- 48 Magnitude of Collision Deaths
- 49 Patterns of Mortality
- 50 Birds and Night Time Light Pollution
- 51 Landscaping and Vegetation

### References

*We have the opportunity to construct well-designed buildings that are also bird-friendly...*



### **Ryerson Student Learning Centre**

The glass exterior of the Ryerson University Student Centre incorporates strong visual markers, making it bird-friendly.

Design by: Zeidler Partnership Architects and Snøhetta

Photo: Lorne Bridgman



### **Picasso Condominium**

The exterior envelope of the Picasso Condominium Building is only 43 percent glazing as compared to the typical condominium in Toronto which may include upwards of 70 percent glass. The building's facade was designed to achieve higher levels of energy performance by reducing the area of exterior glazing, with the co-benefit of a significantly more bird-friendly design.

Design by: Teeple Architects Inc.

Rendering by: Teeple Architects Inc.

Bird-Friendly Best Practices **Glass 5**



6 Bird-Friendly Best Practices **Glass**



Northern (Yellow-shafted) Flicker  
Photo: Mark Peck

## Introduction



Northern Flicker • from Common Birds of Toronto • Flap.org  
Drawing by Barry Kent MacKay

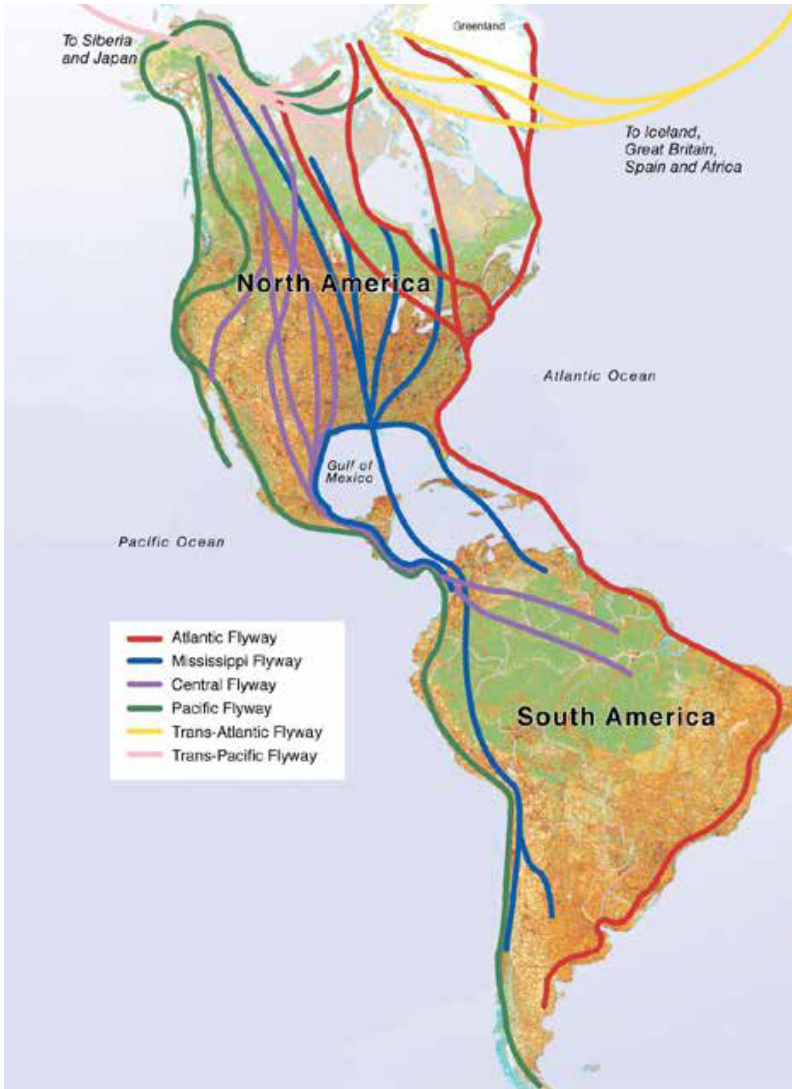

North American Migratory Flyways.  
Image: City of Toronto

8 Bird-Friendly Best Practices **Glass**

### What Is The Problem? Dead Birds

Recent estimates suggest that about 25 million birds die each year from window collisions in Canada. A disproportionately high number of these fatalities occur in Toronto due to its location adjacent to Lake Ontario; at the confluence of the Atlantic and Mississippi Migratory Flyways, and to the fact that it contains one-third of all tall buildings in Canada. Bird mortality is disproportionately higher at mid-rise and high-rise buildings, which are concentrated in urban areas such as Toronto.

Despite the extreme scale of the problem, there are solutions available today that can reduce bird mortality without sacrificing architectural standards.



A dead Common Yellowthroat.  
Photo: FLAP Canada



## Leadership in Bird-Friendly Design

### Council Action - 2005

As a result of citizen scientists and the Fatal Light Awareness Program (FLAP Canada) drawing attention to this issue, in April 2005, Toronto City Council adopted Motion J(17) regarding the “Prevention of Needless Deaths of Thousands of Migratory Birds in the City of Toronto”. This led to the development of the “Bird-Friendly Development Guidelines” (the Guidelines), which was released in 2007.

### Bird-Friendly Development Guidelines - 2007

Toronto’s 2007 Bird-Friendly Development Guidelines was the first Council-adopted document of its kind in North America. The award winning Guidelines provided several strategies and options for making new and existing buildings less of a threat to migratory birds, with a focus on the two key issues that are of critical importance – making glass less dangerous to birds and mitigating light pollution. These strategies could be voluntarily incorporated into the design of new buildings and into retrofit projects of existing buildings by developers and owners respectively.

### Toronto Green Standard - 2010

In 2010, the Toronto Green Standard (TGS) came into effect for new development in Toronto. The TGS established performance measures for green development based on local environmental drivers. Performance measures for reducing bird collisions were incorporated into the TGS, thereby defining a green building in Toronto as one that must also be bird-friendly. The bird-friendly standards contained in the TGS have been refined from the 2007 Guidelines to include those that can be implemented through the planning approval process in the Province of Ontario. Toronto demonstrated leadership and innovation by being the first municipality in North America to require new development to incorporate bird-friendly standards.

In 2014, the TGS was revised after substantial consultation with the public, architects, planners, designers and the development industry. The consultation process identified the standards for bird-friendly design as the most challenging for the development industry to implement. As a result, the standards were revised. Some were altered, some were amplified, and some were discarded all in the best interest of mitigation and, ultimately, prevention of bird fatalities from striking buildings.



Toronto is the first municipality to require bird-friendly standards.



Images: City of Toronto

## Why A Best Practices Manual?

Since the publication of the Bird-Friendly Development Guidelines in 2007, great advances have been made in the understanding of bird collisions and bird mortality from collisions with buildings. This is a topic of ongoing research by the scientific community working in this area, and resulting policy development by municipalities in Canada and the United States. The Best Practices for Bird-Friendly Glass has been developed as a supporting document to the TGS 2014 and elaborates upon the original bird-friendly strategies.

'Best Practices' answers many of the most common questions on bird-friendly design and provides local examples of strategies used to reduce the number of birds that die each year in Toronto.

This document is intended to assist with the understanding of the issues and the implementation of the Toronto Green Standard.



Dark-eyed Junco killed by colliding with window in downtown Toronto.

Photo: Simon Luisi, FLAP Canada

## Ontario Legal Context

In 2011, a prominent development company was prosecuted under Ontario's Environmental Protection Act (EPA) and the federal Species at Risk Act (SARA) for bird window strikes at one of its sites in Toronto.

In February 2013, Justice Melvyn Green of the Ontario Court of Justice found, beyond a reasonable doubt, that the company was responsible for hundreds of bird deaths at its site. Judge Green ultimately acquitted the company on the basis that it had exercised due diligence in attempting to address the problem by taking measures to install visual markers on the most lethal facades of its buildings. However, the case makes it clear that owners or managers of buildings whose design results in death or injury to birds could be found guilty of an offence if they fail to take all reasonable preventative measures.

The judge's ruling found that the reflected light discharged from the building was a "contaminant" under the EPA. Owners and managers of buildings whose windows reflect light as a contaminant are violating s.14 of the EPA, as well as s. 32 of the SARA where death or injury occurs to a species at risk. In summary, it is now an offence under Ontario's EPA and the federal SARA for a building to emit reflected light that kills or injures birds.

The issue of bird deaths and injuries caused by collisions with building glass due to reflected light is now in the judicial realm. Therefore, it is important and prudent for architects, engineers, developers and owners to adhere to current best practices to prevent these collisions and to demonstrate that all reasonable preventive measures have been taken.

Black-capped Chickadees killed at  
a two-storey building one morning in 2010.

Photo: FLAP Canada





**American Robin**  
Photo: Mark Peck

12 Bird-Friendly Best Practices **Glass**



The Cause:  
Light and Glass

Photo: NASA



The clear glass corner of this building in downtown Toronto poses a lethal threat to birds.

Photo: Hanna del Rosario

14 Bird-Friendly Best Practices **Glass**

## Light

Migratory birds are unable to adapt to the urban environment. It has been observed that many have evolved to travel at night when they are safer from predators; and the cooler temperatures enable them to expend less energy. To find their way during these flyovers, birds use natural cues including the moon and stars to navigate. Light emanating from urban areas obscures these natural cues, which disorients and confuses the migrating birds. Light attracts them into the unfamiliar urban environment where they subsequently get trapped, hence the term “fatal light attraction”. Once trapped, birds will attempt to take shelter in whatever habitat they can find.

## Glass

The urban environment contains a number of hazards to birds, many of which are common and hard to avoid. Unlike humans, birds cannot perceive images reflected in glass as reflections and will fly into windows that appear to be trees or sky. Clear glass also poses a danger as birds have no natural ability to perceive clear glass as a solid object. Birds will strike clear glass while attempting to reach habitat and sky seen through corridors, windows positioned opposite each other in a room, ground floor lobbies, glass balconies or glass corners. The impact of striking a reflective or clear window in full flight often results in death.

Experiments suggest that bird collisions with windows are indiscriminate. They can occur anywhere, at any time, day or night, year-round, across urban and rural landscapes, affecting migratory, resident, young, old, large, small, male and female birds.

## Why is the Problem getting Worse?

### Growth of Cities

The upward and outward growth of urban areas around the world has both degraded the quality of existing natural habitat and increased the number of hazards found in cities. As human activity encroaches on shorelines, wetlands, ravines and meadows, stopover locations for migrating birds are becoming smaller and more fragmented. Urban intensification also brings larger and taller buildings that increase the number of obstacles for migrating birds.

### Expanded Use of Glass in Architecture

The amount of glass in a building is the strongest predictor of how dangerous it is to birds. As changes in production and construction techniques facilitated the greater use of glass, cities have become more dangerous for birds to navigate through.

The development of the curtain wall system and the invention of the float glass technique led directly to the expanded use of glass in modern architecture.

Today it is now common to see buildings with the appearance of complete glass exteriors. The increase of curtain wall and window wall glazing, as well as picture windows on private homes, has in turn increased the incidence of bird collisions. Today, the vast majority of Toronto's new mid to high rise buildings contain more than 60 percent glass. Historic masonry structures, with their "punched" windows, used less glass area per facade, and the glass itself, by necessity of manufacture and transportation, was divided into panes by muntins. Further, operating windows frequently had exterior insect screens, rendering them completely bird-friendly.

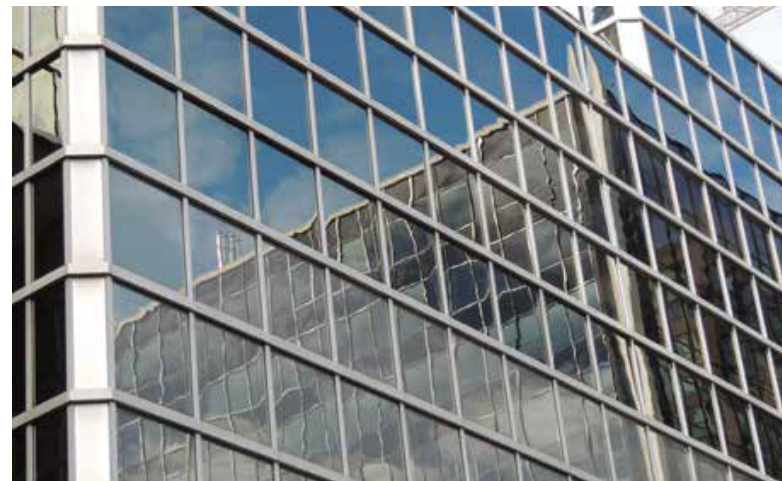

Photo: FLAP Canada



Old City Hall

Image: City of Toronto



Cedar Waxwing  
Photo: Mark Peck

16 Bird-Friendly Best Practices **Glass**





# The Problem: Glass

Photo: Daniel Woolfson

## Properties of Glass

Glass can appear very differently depending on a number of factors, including how it is fabricated, the angle at which it is viewed, and the difference between exterior and interior light levels. Combinations of these factors can cause glass to look like a mirror or dark passageway, or to be completely invisible. Humans do not actually “see” most glass, but are cued by context such as mullions, roofs or doors. Birds, however, do not perceive right angles and other architectural signals as indicators of obstacles or artificial environments.



Photo: Hannah del Rosario

## Reflection

Viewed from outside, transparent glass on buildings is often highly reflective. Almost every type of architectural glass, under the right conditions, reflects the sky, clouds, or nearby habitat and appears familiar and is attractive to birds. When birds try to fly to the reflected habitat, they hit the glass. Reflected vegetation is the most dangerous, but birds also attempt to fly past reflected buildings or through reflected passageways.



Photo: Gabriel Guillen

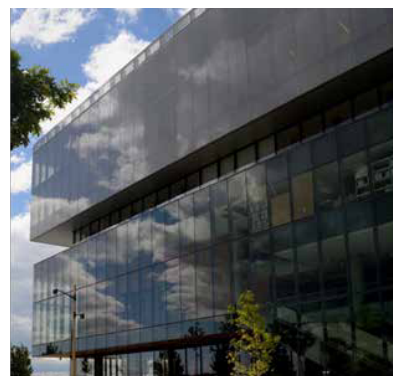

Photo: Gabriel Guillen

18 Bird-Friendly Best Practices **Glass**

## Transparency

Birds strike transparent windows as they attempt to access potential perches, plants, food or water sources, and other lures seen through the glass. Glass “skywalks” connecting buildings, glass walls around planted atria, windows that form glass corners and exterior glass guardrails or walkway dividers are dangerous because birds perceive an unobstructed route to the other side.



Photo: John Carley

## Black Hole or Passage Effect

Birds often fly through small gaps, such as spaces between leaves or branches, nest cavities, or other small openings. In some light, glass can appear black, creating the appearance of a cavity or “passage” through which birds try to fly.



Photo: Gabriel Guillen

## Building Features that Influence Bird Collisions

Untreated glass is responsible for virtually all bird collisions with buildings. The relative threat posed by a particular building depends significantly on the amount of exterior glass, as well as the type of glass used, and the presence of glass “design traps”. In a study based on data from Manhattan, New York, Dr. Daniel Klem found that a 10 percent increase in the area of reflective and transparent glass on a building facade correlated with a 19 percent increase in the number of fatal collisions in the spring and a 32 percent increase in fall.

### Type of Glass

The type of glass used in a building is a significant component of its danger to birds. Mirrored glass is often used to make a building “blend” into an area by reflecting its surroundings. Unfortunately, this makes those buildings especially deadly to birds. Mirrored glass is reflective at all times of day, and birds mistake reflections of sky, trees, and other habitat features for reality. Many of Toronto’s most hazardous buildings include mirrored glass. Non-mirrored glass can be highly reflective at one time, and at others, appear transparent or dark, depending on time of day, weather, angle of view, and other variables. Low-reflection glass may be less hazardous in some situations, but does not actively deter birds and can create a “passage effect,” appearing as a dark void that can be flown through.



Photo: Hannah del Rosario

### Building Size

As building size increases, so typically does the amount of glass, making larger buildings more of a threat. It is generally accepted that the lower stories of buildings are the most dangerous because they are at the same level as trees and other landscape features that attract birds. However, monitoring programs accessing setbacks and roofs of tall buildings are finding that birds also collide with higher levels especially during inclement weather at night.



Photo: Gabriel Guillen



Photo: John Carley

### Reflected Vegetation

Glass that reflects shrubs and trees causes more collisions than glass that reflects pavement or grass. Vegetation around a building will bring more birds into its vicinity as reflections of vegetation correlate with more collisions. Studies with bird feeders (Klem et al., 1991) have shown that collisions will be fatal when birds fly towards glass from more than a few feet away.

## Design Traps

Windowed courtyards and open-topped atria can be death traps for birds, especially if they are heavily planted. Birds fly down into such places, and then try to leave by flying directly towards the reflections. Glass sky walks and outdoor guardrails, and building corners where glass walls or windows are perpendicular are dangerous because birds can see through them to sky or habitat on the other side.



Photos: City of Toronto



## Green Roofs And Walls

Green roofs provide many environmental benefits, including habitat elements that are attractive to birds. Recent work shows that well designed green roofs can become functional ecosystems, providing food and nesting for birds. However, green roof features are often located close to glass, for views onto greenspace. This poses a great threat to birds. It is particularly important that glass near rooftop gardens, green roofs and other features such as green walls be treated to be bird-friendly.



Photo: FLAP Canada



Photo: Gabriel Guillen

## Lighting

Interior and exterior building and landscape lighting can make a significant difference to collision rates in any one location. This phenomenon is dealt with in detail in the “Best Practices for Effective Lighting” document.



**Black-capped Chickadee**

Photo: Mark Peck



# The Solution: Bird-Friendly Building Design

Photo: Lorne Bridgeman, Ryerson Student Learning Centre  
Design by: Zeidler Partnership Architects and Snøhetta

## Building Envelope

The overall extent of glass on the building facade is a primary focus of bird-friendly design and retrofit methodologies. The risk of bird collisions increases as the ratio of glass to solid wall increases. As well as contributing to bird collisions, extensive glazed surfaces also contribute to glare and reflection, and create unwanted heat gain. A building designed with a total window surface area of 25-40 percent relative to the entire facade (low window to wall ratio) can reduce fatal bird collisions. When coupled with passive solar strategies such as daylighting, the design can also provide high-quality light, and help reduce energy use for heating and cooling.



**SQ Condominium Building in Alexandra Park**  
 Rendering of a new residential building designed by Teeple Architects. The exterior of Alexandra Park Block 11 is only 3 percent glazing, significantly reducing the bird collision hazard posed by this building.

Rendering: Teeple Architects



**HOT Condos**  
 Rendering of a new low-rise residential development designed by Quadrangle Architects.

Rendering: Quadrangle Architects

24 Bird-Friendly Best Practices **Glass**

## Design to Eliminate Fly-Through Conditions

The elimination of potential fly-through conditions in a building will help to reduce the potential collision hazards a building presents to birds. Glass bridges and walkways, outdoor railings, free-standing glass architectural elements and building corners where glass walls or windows are perpendicular are dangerous because birds can see through them to sky or habitat on the other side.



## Awnings and Overhangs

The design of recessed windows, balconies and awnings can add both visual cues for birds to avoid, as well as reduce the amount of visible glass and the corresponding collision threat. However, awnings and overhangs, and other building-integrated structures do not completely reduce reflections and as such are considered far less effective than visual markers applied directly to glass.



Photo: City of Toronto



Photo: Hannah del Rosario



Photo: John Carley

## Exterior Screens, Grilles, Shutters and Sunshades

Many buildings that are considered good examples of bird-friendly design have achieved this by virtue of incorporating unique architectural elements that provide clear visual cues for birds to avoid without impacting views from the interior of the building. Decorative facades that wrap entire structures can reduce the amount of visible glass and thus the threat to birds. Netting, screens, grilles, shutters and exterior shades are commonly used elements that can make glass safer for birds. They can be retrofitted on an existing building or integrated into the design of a new building, and can significantly reduce bird mortality.

## Creating Visual Markers:

### Frit, Film and Acid-Etched Patterns

Once the amount of visible glass and high threat features have been minimized, the remaining glass must be made bird-friendly. Natural features in the wild do not reflect images in the way glass does, rather they project 'visual markers' to birds, indicating to them that they are solid objects to be avoided. There are two means of mitigating the danger glass poses to birds. The first and most effective approach is to create visual markers. The second and less effective strategy is to mute reflections in glass.

Glass can have an image or pattern screened, printed, or applied to the glass surface. Ceramic frit and acid-etched patterns are commonly used to achieve other design objectives including a reduction in the transmission of light and heat, privacy screening or branding. By using patterns of various sizes and densities, manufacturers can create any kind of image, translucent or opaque. The image in the glass then projects enough visual markers to be perceived by birds.

Studies have shown that visual markers spaced at a maximum of 10 cm apart are effective at deterring bird collisions with glass. The size of the visual marker, and spacing between them have been found, by testing and observation, to be the most effective at diminishing the risk of bird collisions. The denser the pattern, the more effective it becomes in appearing as a solid object to birds. The markers must also be high contrast. If contrast is subtle to the human eye, it will also be subtle to birds.

Only non-reflective glass should be used in combination with ceramic frit patterns. The visual markers are most visible on Face 1 (exterior surface) of the glass, as they are not obscured by reflections. Face 2 or Face 3 applications are of assistance, but are of secondary and diminished value. With these parameters, a wide variety of aesthetic solutions are possible, enhancing the design of the building.

DIY window film for homeowners will provide visual markers to glass.

Photo: FLAP Canada

26 Bird-Friendly Best Practices Glass





Photo: John Carley



Photo: FLAP Canada



Photo: MMC Architects



Photo: MMC Architects



Photo: FLAP Canada



Photo: FLAP Canada

## Tips for Designing Visual Markers

*Select a pattern.*

*Any design will be effective if it meets the following criteria:*

- Ensure the pattern density is 10 cm by 10 cm or less;
- Visual markers must be at least 5 mm in diameter
- Visual markers are applied to low reflectance glass
- Visual markers should be high contrast
- Face 1 (exterior surface) is the most effective surface to deter bird collisions

Acid-etching patterns will provide similar visual markers to that of fritted glass. Acid-etched patterns on the first (exterior) surface of the glass provide both visual cues and break up any reflections on the glass surface.

Exterior bird-friendly films applied directly to the glass are a less permanent but similarly effective solution. The lifespan of exterior film will be a fraction of the operating life of a building and is not recommended for new construction. This type of film is most commonly used in retrofit situations.

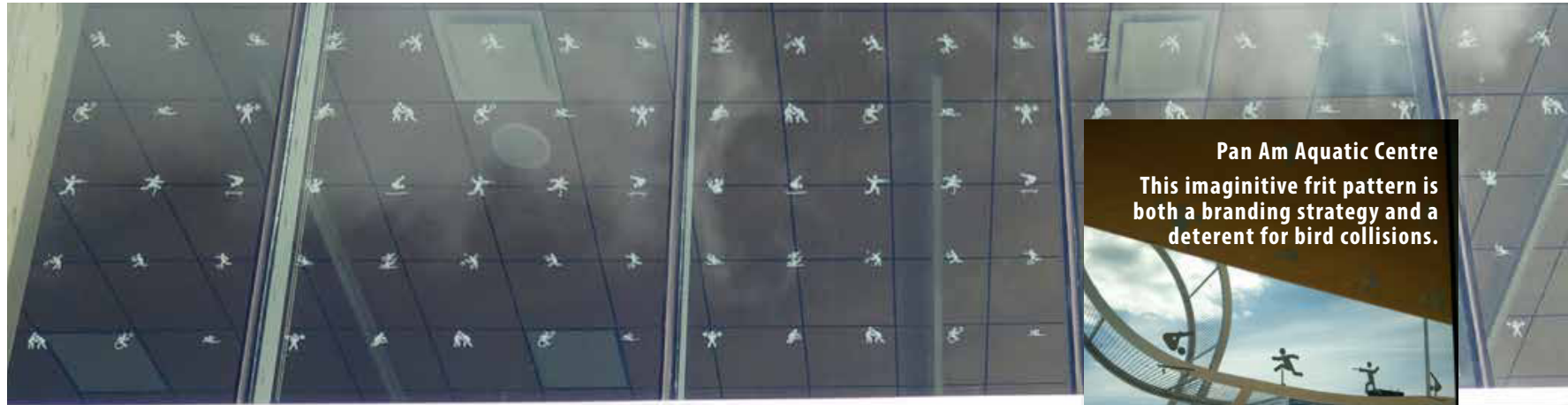

**Pan Am Aquatic Centre**  
This imaginative frit pattern is both a branding strategy and a deterrent for bird collisions.



Photos: Karen Jiang



## Opaque and Translucent Glass

Opaque, etched, stained, and frosted glass, as well as glass block are excellent options to reduce or eliminate collisions and are commonly used in new construction. Frosted glass is created by acid etching or sandblasting the exterior surface of transparent glass. This process both reduces the reflectivity of the exterior surface and makes the glass translucent, appearing to birds as something to avoid. An entire surface can be frosted, or frosted patterns can be applied. Patterns should be applied at a 10 cm by 10 cm spacing. For retrofits, glass can be frosted by sandblasting on site. Stained glass is typically seen in relatively small areas but can be extremely attractive and is not conducive to collisions. Glass block is extremely versatile, can be used as a design detail or primary construction material, and is also unlikely to cause collisions.

Photo: FLAP Canada

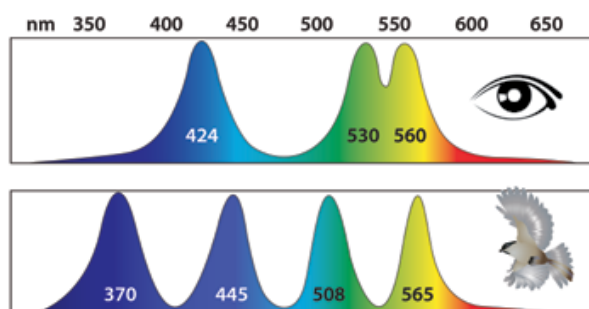

Illustration: American Bird Conservancy

## UV Glass (or similar products)

Birds have evolved to perceive the ultraviolet (UV) spectrum of light. Thus, any glass product that is able to reflect and/or absorb UV light would appear solid to a bird but clear to the human eye. Several products with this ability are already available. In order to be accepted as bird-friendly, a product that makes this claim would need to provide demonstrable, third party testing results that clearly indicate a significant reduction in bird collisions comparable to acid-etched and/or fritted glass treated to the performance measures set out in the 2014 Toronto Green Standard version 2.0.

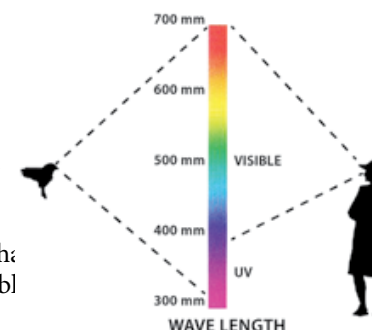
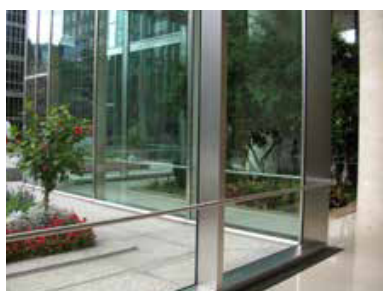

Illustration: New York City Audubon



## Low Reflectance Glass

As discussed in the preceding sections, mirrored glass is the most reflective of all building materials and should be avoided in all situations. Lower reflectance glass (less than 15 percent reflectance) may reduce collisions in some situations, but does not actively deter birds and can create a “see-through” effect. Low-reflectance glass on its own is not considered a treatment and must be coupled with visual markers to be considered bird-friendly.

Photo: FLAP Canada

## Ineffective Strategies

### Angled glass

In the 2007 Bird-Friendly Design Guidelines, it was suggested that angling glass panes downward at 20 to 40 degrees is an effective means of deterring bird strikes at ground level. Due to the architectural challenges involved in utilizing this strategy and the lack of scientific evidence supporting the effectiveness, angled glass is no longer accepted as a suitable strategy.

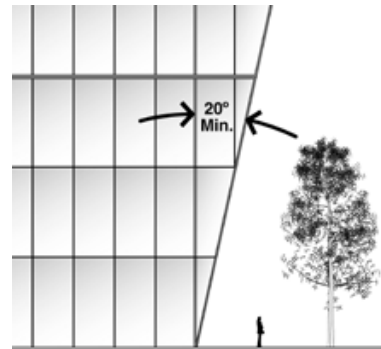

Angled Glass is no longer accepted

Illustration: City of Toronto

### Blinds

Interior blinds installed behind windows have been used as a means of deterring bird collisions on the assumption they provide sufficient visual markers to make a window appear as a solid object. However, while it is possible to require the installation of blinds by a developer through the Site Plan process, there is no mechanism to ensure or require that blinds be utilized by the tenant during the migratory seasons and/or that the building owner or manager will require this of their tenants. Due to this fact, blinds are not accepted as a suitable strategy.



Blinds not always utilized by tenants

Photo: FLAP Canada



Unacceptable to use Tinted Glass

Photo: FLAP Canada

### Tinted Glass

There is no definitive evidence that tinted glass has a positive effect in reducing bird collisions. Tinted glass is not an acceptable option or strategy for meeting the Toronto Green Standard "Bird Collision Deterrence" requirements.

## Interior Screens

In the 2007 Bird-Friendly Design Guidelines, it was suggested that installing permanent internal screens may provide enough visual markers through non-reflective glass for birds to perceive the windows as solid objects. It was stated that they must be installed as close to the glass as possible to maximize the visual markers projected through the window. Due to the variability in the possible distance from the window and the lack of scientific evidence supporting the effectiveness of this strategy, interior screens are no longer accepted as a suitable strategy.



Interior Screens are not a suitable strategy

Photo: Gabriel Guillen

## Bird Decals

It has been a popular belief that large opaque silhouettes of birds of prey will deter other birds from frequenting an area. This is not the case. Bird silhouettes have, unfortunately, been proven to be ineffective at reducing collisions applied in this manner. Commonly used bird of prey silhouettes have been tested experimentally and found to be largely ineffective. Birds will avoid hitting the decal if it is applied on the exterior surface of the window, but may still hit glass beside the decal if it reflects vegetation or sky. To be effective, decals would have to be applied on a window in a pattern of 5 to 10 cm apart.



One or two Bird Decals are ineffective

Photo: FLAP Canada



Red Knot  
Photo: Mark Peck





**Applying Bird-Friendly Design  
to New Development in Toronto**

Bird Safe Glass  
Acid Etched Pattern Surface  
Photo: AviProtek E



Image: City of Toronto

## Toronto Green Standard

### Standards for New Development

The Toronto Green Standard (TGS) has been a requirement for all new development through the planning process since 2010. The bird-friendly performance measures set out in the TGS are required as a matter of exterior sustainable design (s. 114 City of Toronto Act, 2006). This includes applications for rezoning, plan of subdivision and site plan control.

The requirements for Bird Collision Deterrence in the Toronto Green Standard are applied to the following building types:

- Residential development 4 storeys and higher
- All non-residential development
- Low-rise residential development (under Part 9 of the Ontario Building Code) that is abutting a ravine or natural area and contains more than 5 units

## Areas Requiring Glass Treatment

All glass poses a collision risk to birds and must be treated when within the required areas. Building designs that reduce the total exterior glazing also reduce the total area that must be treated.

The Toronto Green Standard requirements focus on reducing the hazards within areas that pose a higher risk of collision, such as:

- 0-12 m above grade: exterior glass, fly-through conditions and balcony railings
- 4 m above rooftop vegetation: exterior glass, fly-through conditions and balcony railings
- At all heights: parallel glass such as bridges and walkways

## ECOLOGY



### For New Mid to High-Rise Residential and All Industrial, Commercial and Institutional (ICI) Development

Development Feature	Required Tier 1	Voluntary Tier 2	Specifications, Definitions and Resources	Potential Strategies
<p><b>Bird Collision Deterrence</b></p> <p>Design buildings to reduce bird collisions and mortality</p>	<p><b>EC 4.1 Bird friendly glazing</b></p> <p>Use a combination of the following strategies to treat a minimum of 85% of all exterior glazing within the first 12 m of the building above grade (including balcony railings, clear glass corners, parallel glass and glazing surrounding interior courtyards and other glass surfaces):<sup>1,2</sup></p> <ul style="list-style-type: none"> <li>• Low reflectance, opaque materials<sup>3</sup></li> <li>• Visual markers applied to glass with a maximum spacing of 100 mm x 100 mm<sup>4</sup></li> <li>• Building-integrated structures to mute reflections on glass surfaces.<sup>5</sup></li> </ul> <p><u>Balcony railings:</u> Treat all glass balcony railings within the first 12 m of the building above grade with visual markers provided with a spacing of no greater than 100 mm.<sup>4,6</sup></p> <p><u>Fly-through conditions:</u> Glass corners: Within the first 12m of the building, treat all glazing located at building corners with visual markers at a spacing of no greater than 100 mm x 100 mm.<sup>7</sup></p> <p><u>Parallel glass:</u> Treat parallel glass at all heights with visual markers at a spacing of no greater than 100 mm x 100 mm.<sup>7</sup></p> <p><u>City-owned buildings and all Agencies, Boards, Commissions and Corporations:</u> For new buildings or major renovations, treat all exterior glazing within the first 16 m of the building above grade as per the requirements of EC 4.1 above; visual markers applied to glass must have a maximum spacing of 50 mm x 50 mm<sup>8</sup>.</p>	<p><b>EC 4.4 (Optional) Enhanced bird friendly glazing</b></p> <p>Use a combination of the following strategies to treat a minimum of 95% of all exterior glazing within the first 12 m of the building above grade (including all balcony railings, clear glass corners, parallel glass and glazing surrounding interior courtyards and other glass surfaces):<sup>1,2</sup></p> <ul style="list-style-type: none"> <li>• Low reflectance, opaque materials<sup>3</sup></li> <li>• Visual markers applied to glass with a maximum spacing of 100 mm x 100 mm<sup>4</sup></li> <li>• Building-integrated structures to mute reflections on glass surfaces.<sup>5</sup></li> </ul> <p><b>EC 4.5 (Optional) Opaque building materials</b></p> <p>Provide at least 50% of the exterior surface of the building as non-reflective opaque materials to significantly reduce bird collisions with buildings.</p>	<ol style="list-style-type: none"> <li>1. Bird friendly design aims to reduce bird collisions and mortalities caused by reflective glazing by: making glazed areas visually distinct to birds and by reducing images of trees or sky reflected in glass through shading/muting reflections. The most critical zone for bird collisions is 12 m minimum above grade (mature tree height).</li> <li>2. If the site is adjacent to a natural area feature, glass must be treated to the first 12 m of the building or to the height of the top of the surrounding tree canopy at maturity, whichever is greater.</li> <li>3. Low reflectance, opaque materials may include spandrel glass with one of the following: (i) Solid back-painted frit or silicone backing opaque coatings OR; (ii) Reflective or low-e coatings that have an outside reflectance of 15% or less. Spandrel glass with reflective or low-e coatings that have an outside reflectance of greater than 15% should be used in combination with other strategies.</li> <li>4. Visual markers consist of opaque contrasting colors or patterns etched into or applied onto the exterior or interior surfaces of glass and must have a minimum diameter of 5 mm and a maximum spacing of 100 mm x 100 mm. Patterns applied closer to the first (exterior) surface, in combination with low reflectance glass, are most visible and effective.</li> <li>5. Building integrated structures include: opaque awnings, sunshades, exterior screens, shutters, grilles and overhangs or balconies that provide shading below a projection (assume 1:1 ratio of treatment below a projection) to mute reflections. Shade cast by the building or adjacent buildings cannot be included as a bird collision deterrence strategy.</li> <li>6. Glass behind treated balcony railings is considered to be treated.</li> <li>7. Fly-through conditions are created when clear glass corners meet or provide any clear line of sight to birds. Glass corners must be treated for 2.5 m extending on each side away from the corner. Parallel glass is glass installed at any height that is parallel at a distance of 5 m or less such as a clear glass corridor or bridge.</li> <li>8. This requirement applies to City-owned non residential facilities.</li> </ol>	<p>Visual markers: Etched glass Fritted glass Films Decals Mullions</p> <p>Exterior screens, shutters, grilles and louvres to shield glass surfaces</p> <p>Shadows from opaque overhangs, awnings, exterior sunshades</p>

14 Apply this Standard to: New Residential Apartments 4 storeys and higher and ALL Industrial, Commercial and Institutional (ICI) Development

March 2015

Refer to the full Toronto Green Standard Document for the complete set of bird-friendly requirements.

Image: City of Toronto

# Scarborough Civic Centre Branch

Our 100th Library Branch



Photo: Alan Filipuzzi

## Municipal Buildings

For new projects or major renovations, all buildings owned by the City and its Agencies, Boards, Commissions and Corporations are required to provide a higher level of protection for birds by treating exterior glazing within the first 16 m of the building and providing a denser pattern of visual markers on glass at a spacing of 50 mm x 50 mm.



Photo: Monika Hoxha

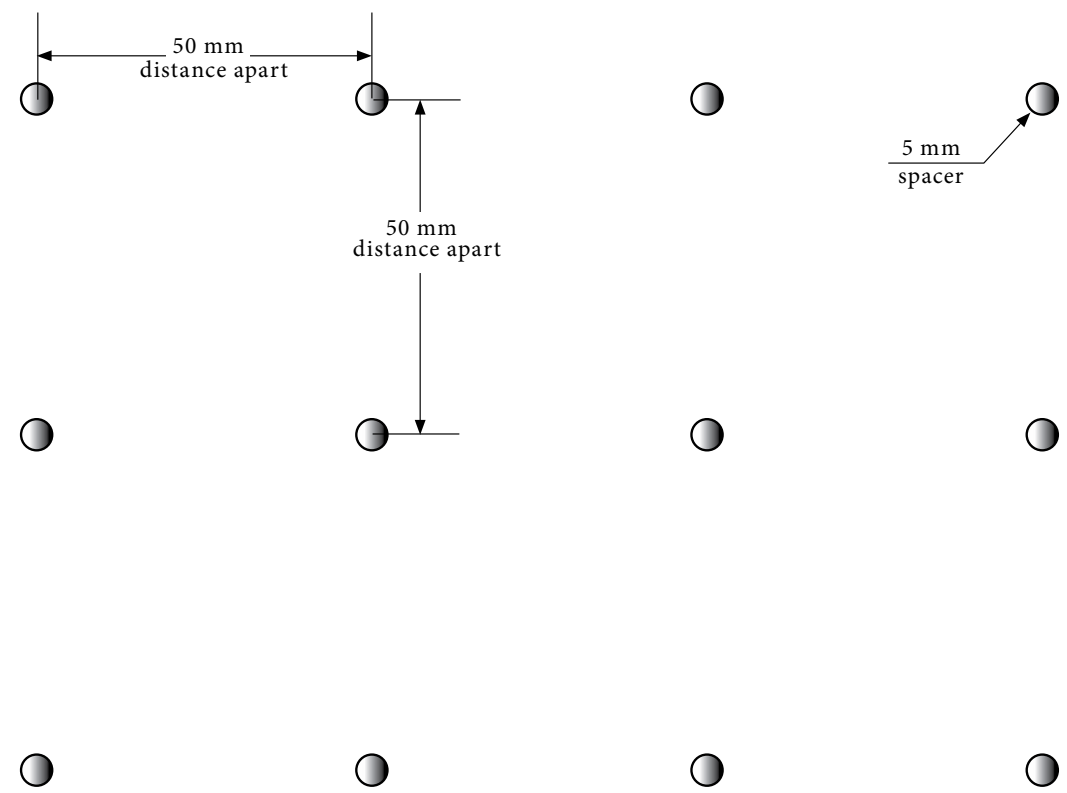

Illustration: Monika Hoxha

## Compliance Strategies (TGS Tier 1)

### Visual markers applied to glass with a maximum spacing of 100 mm x 100 mm

Visual markers consist of opaque contrasting points or patterns etched into or applied onto the exterior or interior surfaces of glass. Patterns applied closer to the first (exterior) surface, in combination with low reflectance glass, are most visible and effective. Areas that pose a high risk for bird collisions must be treated using visual markers including glass balcony railings, fly-through conditions, parallel glass and areas adjacent to rooftop vegetation.

Visual markers must be designed to meet the following criteria:

- minimum diameter of 5 mm
- maximum spacing of 100 mm x 100 mm

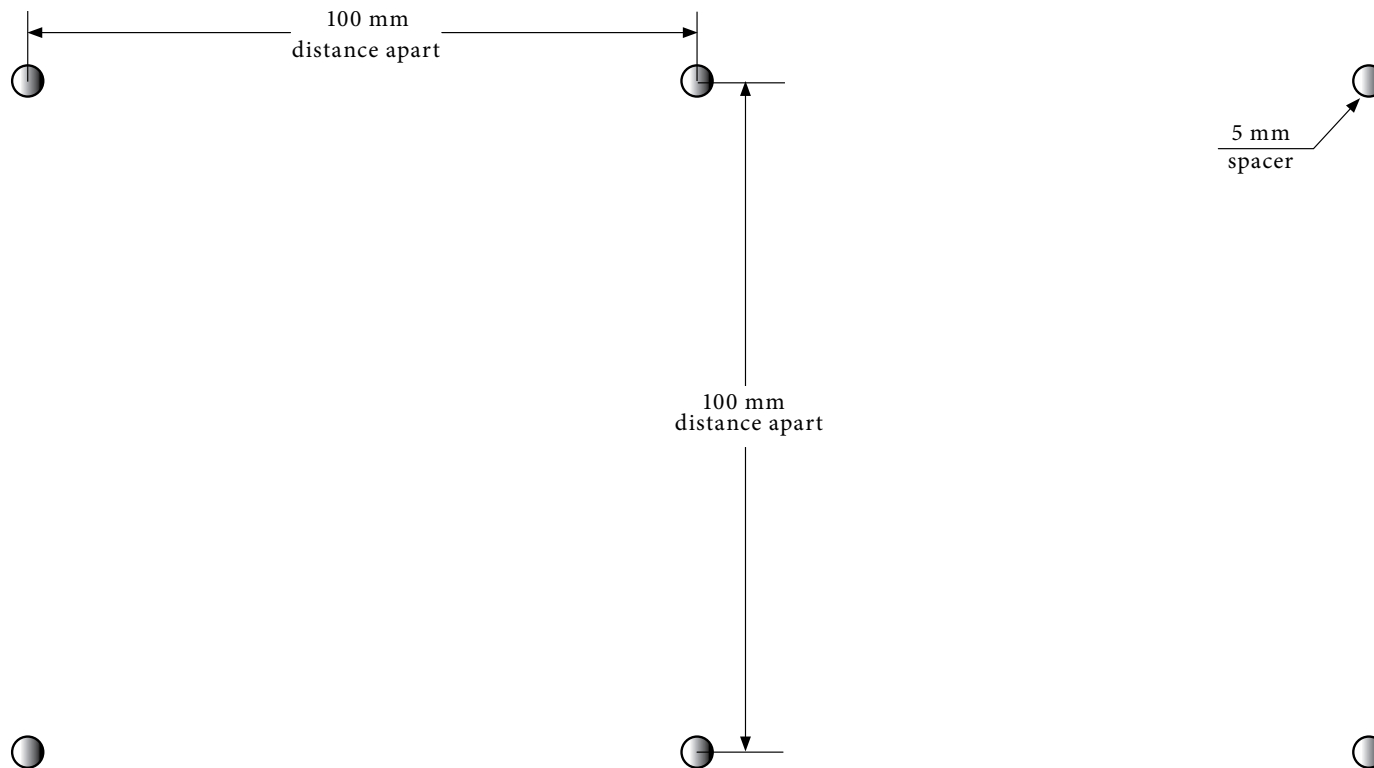

Illustration: Monika Hoxha

## Compliance Strategies (TGS Tier 1)

### EC 4.1 Bird friendly glazing

Use a combination of the following strategies to treat a minimum of 85 percent of all exterior glazing within the first 12 m of the building above grade (including balcony railings, clear glass corners and glazing surrounding interior courtyards and other glass).

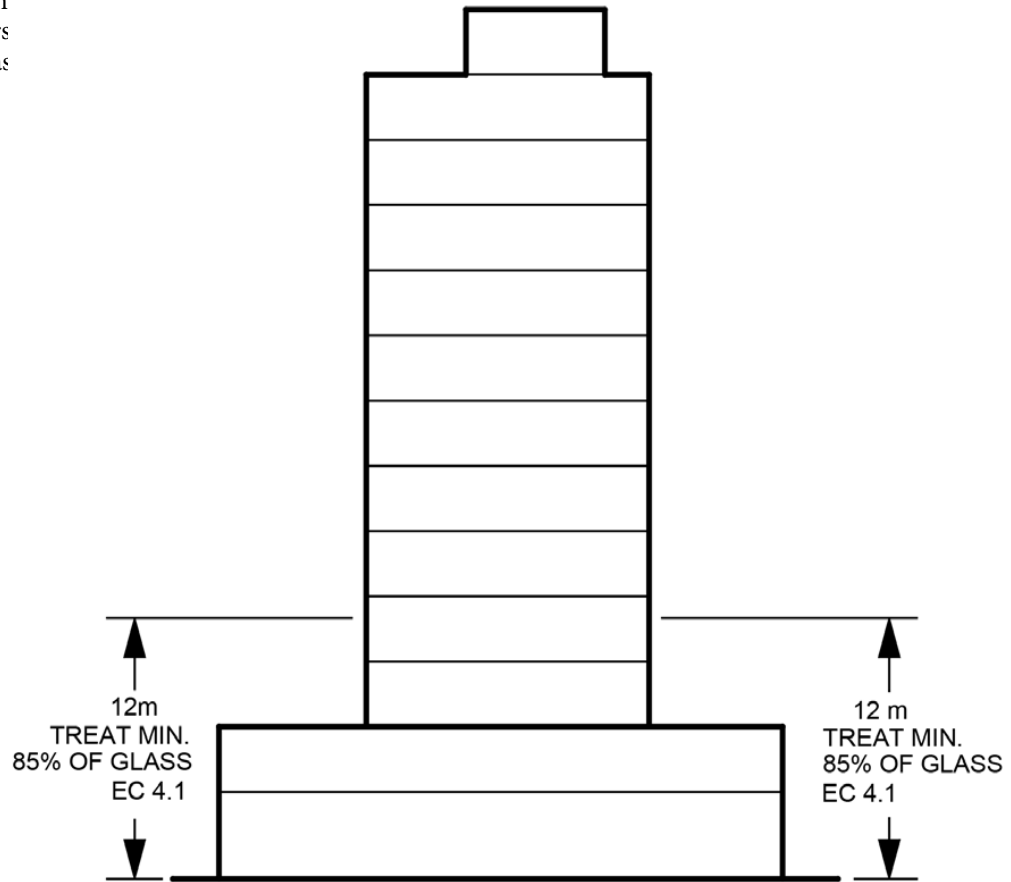
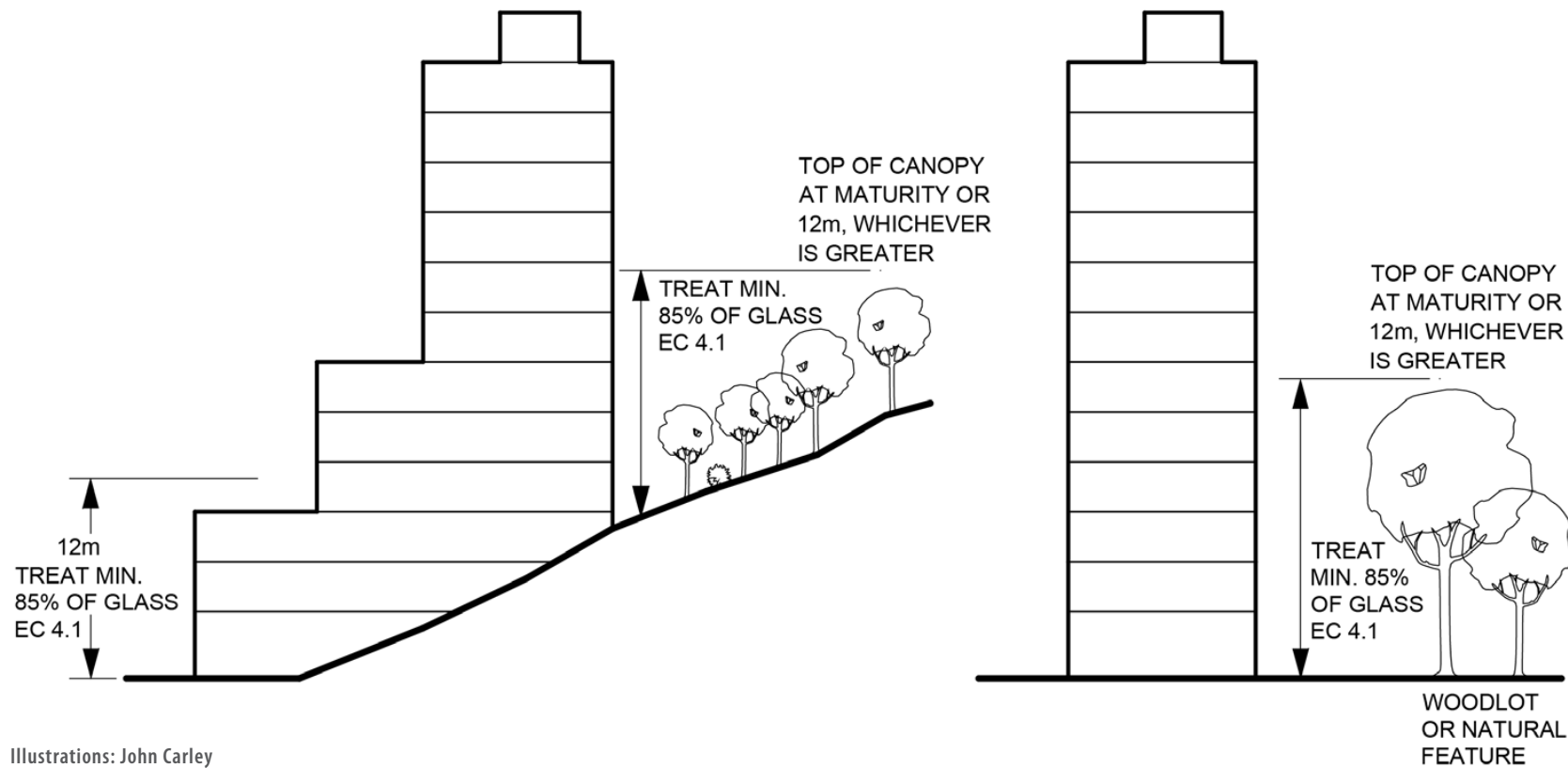

Illustration: John Carley

## Compliance Strategies (TGS Tier 1)

### Buildings Adjacent to Natural Features

Because natural features such as ravines attract greater concentrations of birds, developments that are adjacent to a natural area feature must have glass treated to the first 12 m of the building or to the height of the top of the surrounding tree canopy at maturity, whichever is greater.



## Compliance Strategies (TGS Tier 1)

### Balcony railings

Treat all glass balcony railings within the first 12 m of the building above grade with visual markers provided with a spacing of no greater than 100 mm x 100 mm.

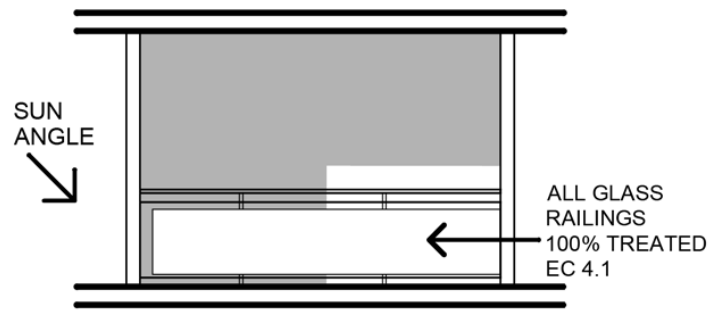
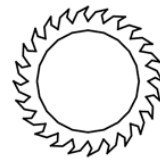

ALL GLASS RAILINGS  
100% TREATED  
VISUAL MARKERS  
AT SPACING NO  
GREATER THAN  
100 mm X 100 mm  
EC 4.1

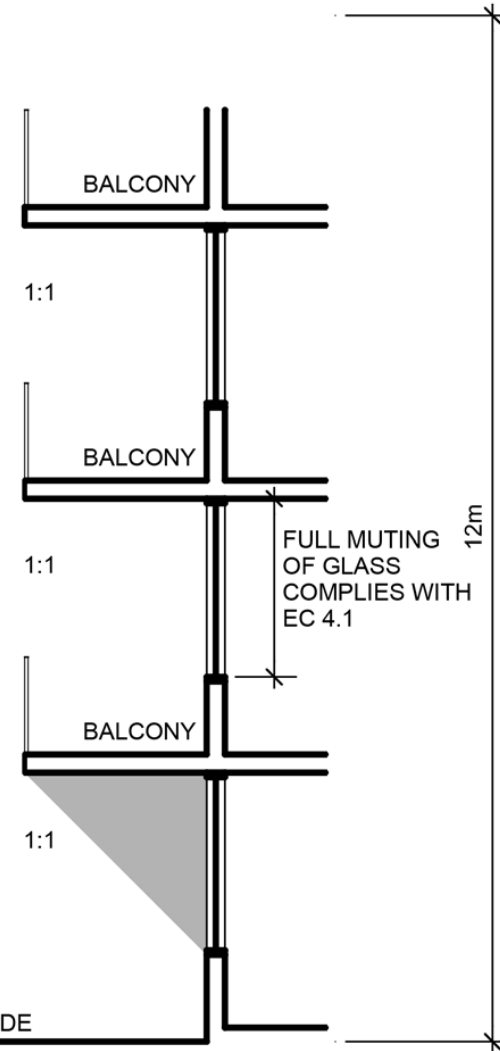

Illustration: John Carley



## Compliance Strategies (TGS Tier 1)

### Fly-through conditions

Glass corners: Within the first 12m of the building, treat all glazing located at building corners with visual markers at a spacing of no greater than 100 mm x 100 mm.

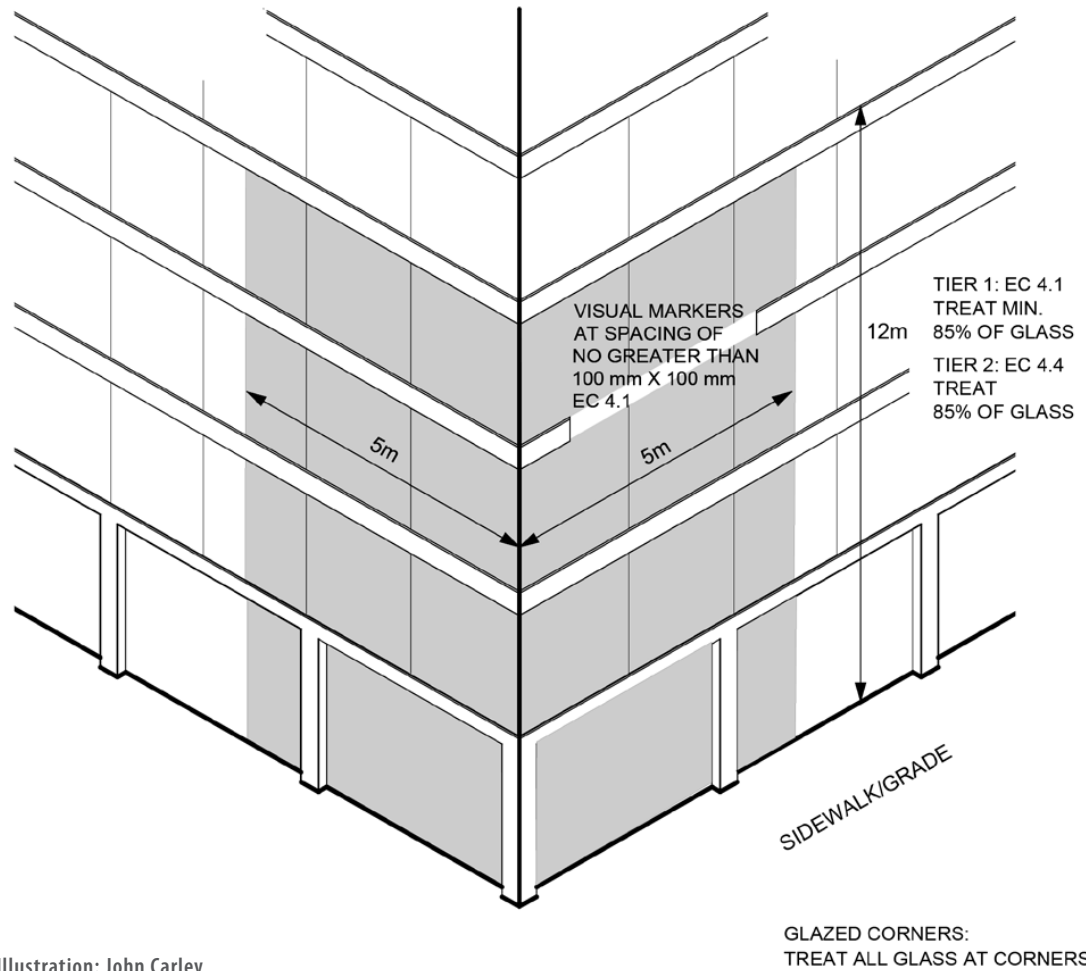

Illustration: John Carley

## Compliance Strategies (TGS Tier 1)

### Parallel glass

Treat parallel glass at all heights with visual markers at a spacing of no greater than 100 mm x 100 mm.

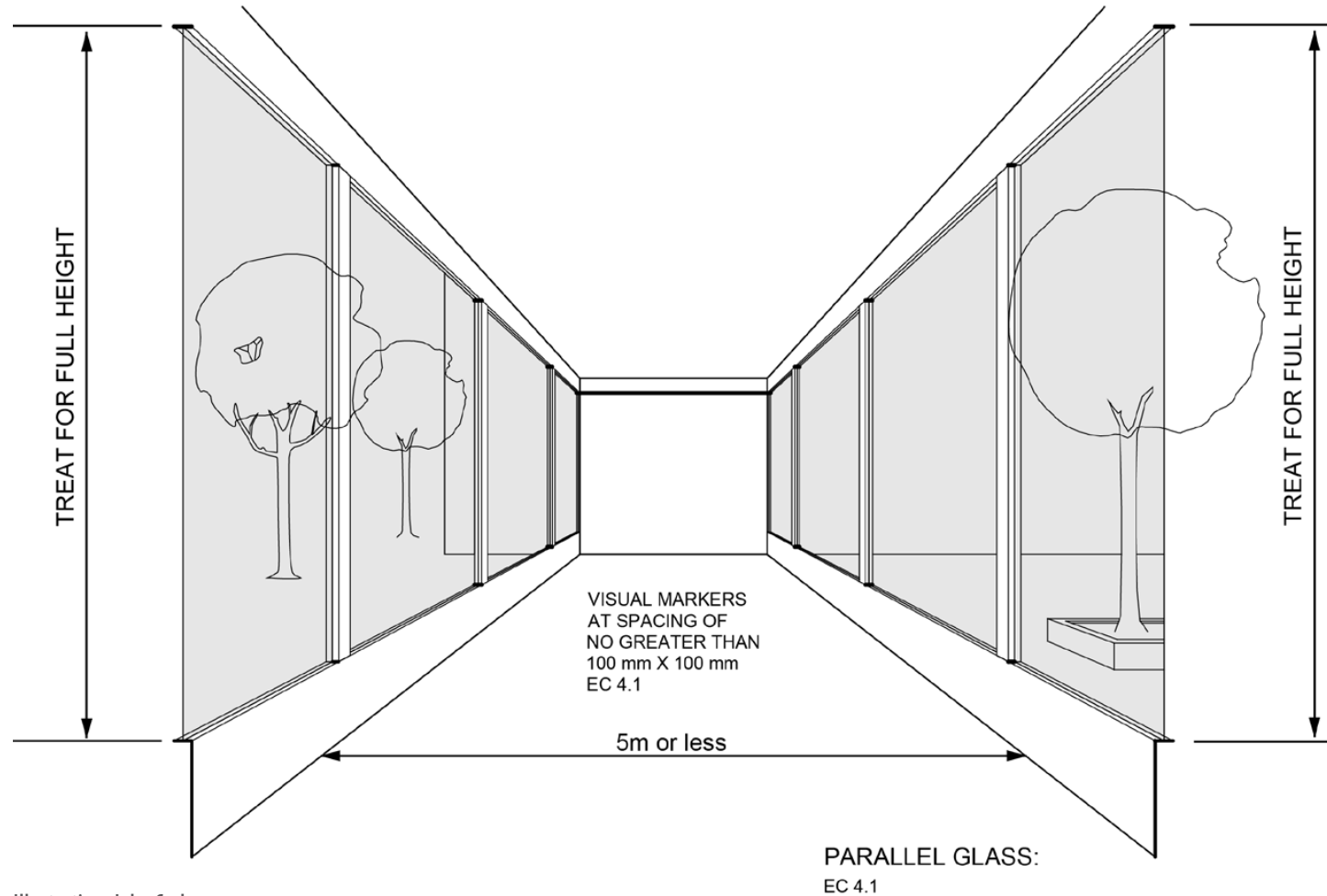

Illustration: John Carley

### Compliance Strategies (TGS Tier 1)

#### EC 4.2 Rooftop vegetation

Treat the first 4 m of glazing above the feature and a buffer width of at least 2.5 m on either side of the feature using strategies from EC 4.1

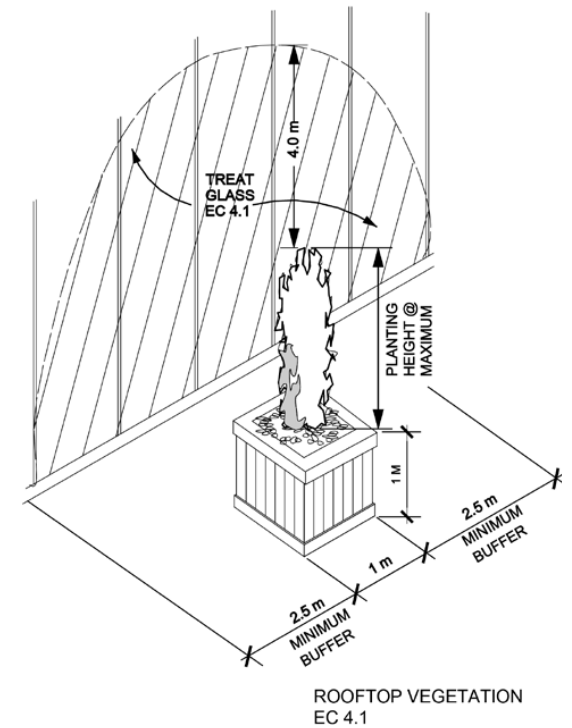
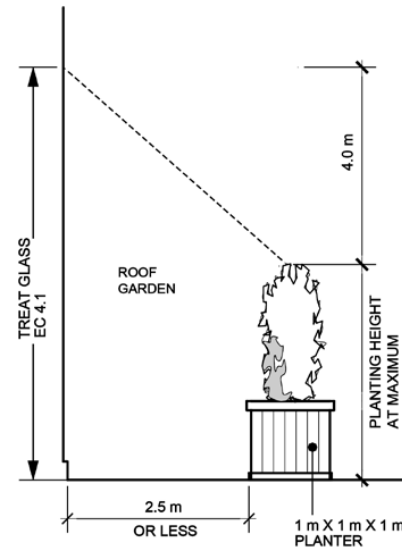
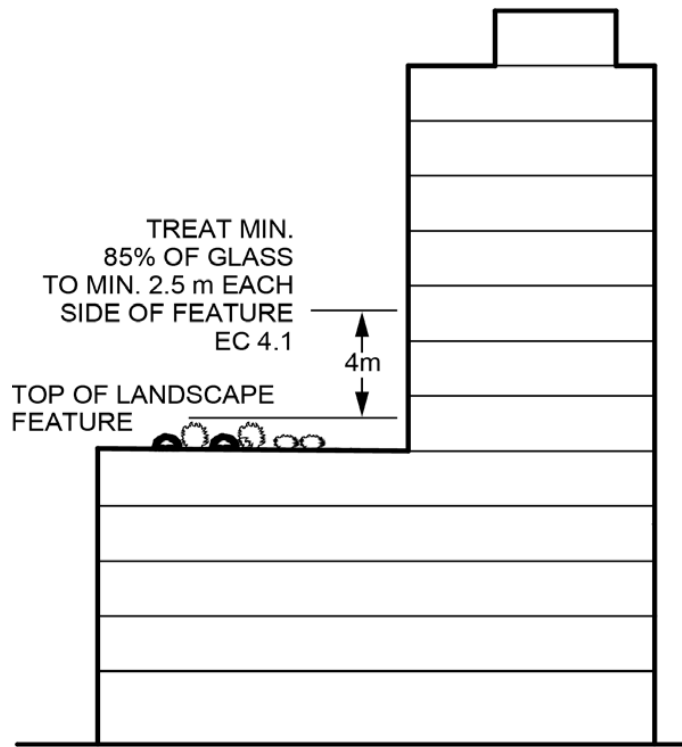

Illustration: John Carley

## Compliance Strategies (TGS Tier 1)

### Low reflectance, opaque materials

Low reflectance, opaque materials may include spandrel glass with one of the following:

- (i) Solid back-painted frit or silicone backing opaque coatings or;
- (ii) Reflective or low-e coatings that have an outside reflectance of 15% or less.

Spandrel glass with a reflective or low-e coating that has an outside reflectance of greater than 15% should be used in combination with other strategies such as visual markers.



Photo: FLAP Canada

## Compliance Strategies (TGS Tier 1)

### Building-integrated structures to mute reflections on glass surfaces

Building-integrated structures obscure glass from view, mute reflections during certain times of the day and provide visual cues for birds to avoid an area. These structures include: opaque awnings, sunshades, exterior screens, shutters, grilles and overhangs or balconies that provide shading below a projection. A 1:1 ratio of treatment below a projection can be assumed to mute reflections. Shade cast by the building or adjacent buildings does not obscure glass or provide any visual cues and cannot be included as a bird collision deterrence strategy.

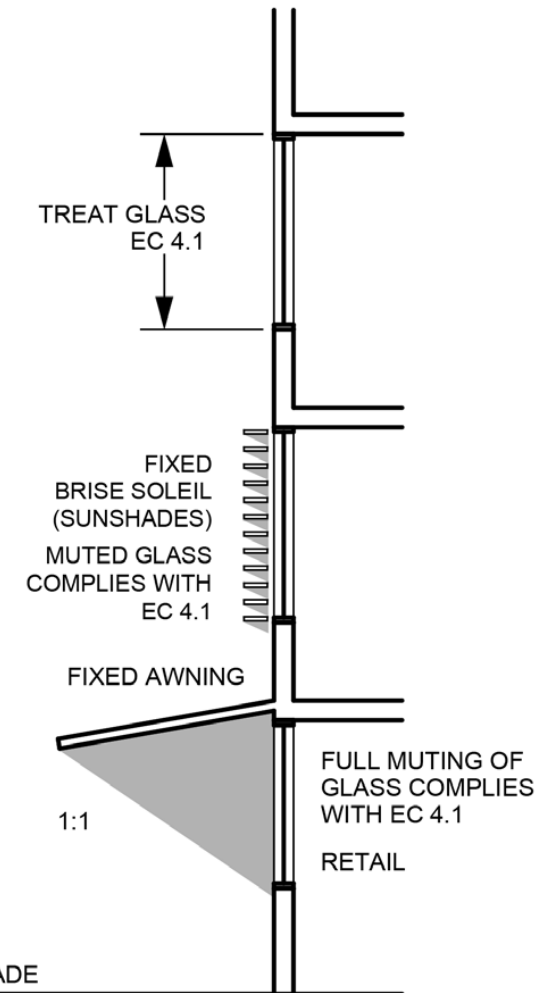

Illustration: John Carley



Photo: Linda Woods,  
Canadian Peregrine Foundation

46 Bird-Friendly Best Practices **Glass**



## Appendix

## Magnitude of Collision Deaths

An alarming number of birds are killed every year due to window collisions: an estimated 25 million birds per year in Canada alone (Machtans, Wedeles and Bayne, 2013). Canadian data is still very limited in terms of recording bird mortality from building collisions. The first Canada-wide estimate was produced by Machtans et al. using data from houses, low-rise buildings, and tall buildings.

A benchmark study by Dr. D. Klem Jr. (1990) estimated that each building in the United States kills one to ten birds every year. He used 1986 United States Census data to then estimate a yearly range of 97.6-975.6 million birds killed. This number has inevitably risen given the continuing increase in new construction across North America.



Sample of collision victims

Photo: FLAP Canada

48 Bird-Friendly Best Practices **Glass**

FLAP (Fatal Light Awareness Program) Canada, a bird conservation initiative working to safeguard migratory birds in the built environment through education, policy development, research, rescue and rehabilitation, has been documenting and collecting bird collision data in Toronto and area since 1993. The City of Toronto is a significant area of focus for bird-window collisions due to its location at the convergence of two migratory flyways and its abundance of low, mid and high-rise buildings abutting Lake Ontario (Cusa, Jackson and Mesure, 2015). This combination of factors results in a disproportionate number of birds being killed at buildings. Data collected by FLAP, however, is only based on a limited number of buildings where frequent collisions occur. FLAP encourages citizen participation in data collection through its on-line Mapper tool, found at FLAP website. This allows citizens to input information about bird collisions that they witness. The tool helps create more conclusive information about bird collisions in Canada and across the globe.

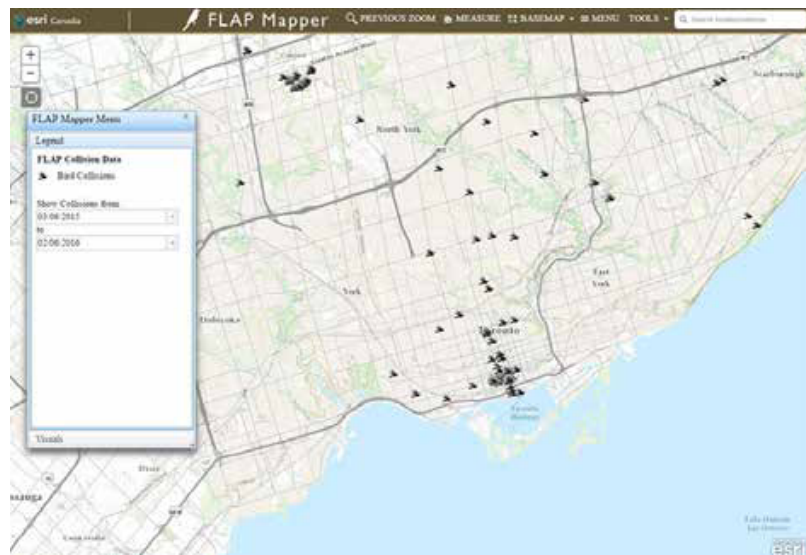

Bird Mapper (Global Bird Impact Recording Database Mapper) also known as FLAP Mapper

Image: FLAP Canada



## Patterns of Mortality

Due to the huge impact of buildings on avian mortality it is very difficult to track the full extent of bird deaths and accurately interpret this data.

Wedeles and Pickard (2015) undertook a study to examine factors which may impact data collection on bird mortality rates. The study examined three issues: the scavenging of birds before they can be collected, the efficiency of searchers, and building architecture which may intercept falling birds before they reach ground level. The study was conducted in downtown Toronto during the spring and fall migration seasons of 2014. Separate experiments were conducted to study scavenging rate and searcher efficiency. Using previously collected birds distributed among the survey site, it was found that searchers (FLAP volunteers) found only 33% of all specimens. It was also found, in a separate survey area, that 55% and 53% of birds were scavenged within 8 hours in the spring and fall, respectively. Finally, it was estimated that 50% of birds were intercepted by buildings so that only half of birds killed by collisions would be found by searchers at ground level. Wedeles and Pickard (2015) used these factors to estimate that for every 100 birds collected, 752 birds are killed. This has huge implications for calculations of bird mortality rates.

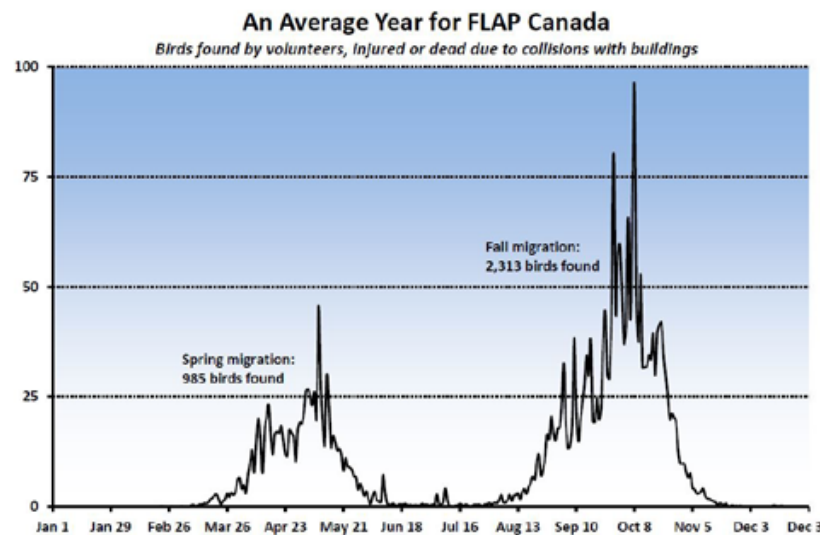

Birds for the study were provided by the Royal Ontario Museum's Ornithology Department. The department maintains a collection of birds found by FLAP Canada volunteers each year, which is catalogued and used for research as well as bird identification training and public awareness campaigns (FLAP, 2016).

Cusa, Jackson, and Mesure (2015) have used data collected in Toronto to further understand species-specific patterns of mortality. In one such study, conducted during the migratory seasons of 2009 and 2010 (April - May, August - October), FLAP volunteers collected data on bird-window collisions at three distinct commercial building sites. The study found that increased glass cover on buildings and increased natural habitat surrounding buildings had an impact on increased bird collisions. They also found that certain migratory species appeared to adapt better to urbanized areas than others. Different species were found to have higher collision rates at the most urbanized downtown site and at the two less-developed areas. The finding that predictable bird family clusters are more likely to collide with buildings at certain geographical regions suggests that future research should consider specific species.

In the study, bird species with the overall greatest number of collisions were the Golden-crowned Kinglet and the White-throated Sparrow. FLAP has published a list of the numbers of all bird species collected (dead or alive) from 1993 to 2014. The Golden-crowned Kinglet and White-throated Sparrow also top this list, along with the Ovenbird, Ruby-throated Hummingbird, Ruby-crowned kinglet, Dark-eyed Junco, and Brown Creeper. To date, twenty four of the species collected by FLAP are on the Ontario or federal Species at Risk lists (pers. com. Susan Kranjc, February 8, 2015).

Seasonal mortality  
patterns of FLAP collisions

Image: FLAP Canada

## Birds and Night Time Light Pollution

Artificial light has long posed a threat to migratory birds, and this threat has increased with rapid urbanization in North America. Migratory birds use a variety of cues for orientation including the sun, Earth's magnetic field, patterns of stars and the moon, and topography. Evidence suggests that visual cues are at least as important, if not more important than cues from Earth's magnetic field, and weather affecting visibility has been found to significantly impact the orientation of migratory birds (Evans Ogden, 1996). The impact of artificial light on nocturnally migrating birds has historically been noted through the impact of lighthouse beams, and is now seen much more substantially in urban areas.



50 Bird-Friendly Best Practices **Glass**

In 1997, FLAP and the World Wildlife Fund Canada initiated the Bird Friendly Building (BFB) Program to address light pollution from buildings and reduce bird mortality. Building managers and tenants of buildings in Toronto's downtown core were educated on bird friendly practices, and buildings which committed to applying these practices were given the Bird Friendly designation. Sixteen buildings ranging from eight to 72 storeys were then monitored between 1997 and 2001 to explore the impacts of light emissions on bird mortality.

Evans Ogden (2002) determined that light emissions do have a significant impact on bird mortality. Also, building height was found to be a less significant factor. Weather was also considered, and found to have a significant impact. Cloud cover and rain in particular were important factors in predicting bird mortality.

Overall, Evans Ogden (2002) found that the BFB program did have a statistically significant impact on bird mortality at the buildings studied. Surveys conducted with building managers determined that tenant awareness programs were the most employed technique in enforcing light emission reduction. Computer-controlled lighting systems were also employed in many of the buildings.

Finally, similar to Cusa, Jackson and Mesure (2015), Evans Ogden (2002) suggested the need for closer examination of bird species-specific trends. The data collected suggested that certain species are at higher risk of building collision, and this should be incorporated into future studies and programs.

[Birds attracted to nighttime light emissions at Yonge-Dundas Square.](#)

Photo: FLAP Canada

## Landscaping and Vegetation

Urban greenery and reflective windows can be a dangerous combination for birds. Cusa, Jackson and Mesure (2015) examined landscape within a 500m radius of study buildings and studied this in a wider geographical context. It was predicted that increased glass surface on a building, greater tree canopy cover, and open habitats in the landscape would all be positively correlated with window collisions. While canopy was not strongly correlated, open habitat and reflective glass surface were found to be significant contributors to collisions.

Overall, there was a notable increase in the effect of reflective glass when surrounded by vegetation. It was found that the bird species most likely to collide with windows in vegetated areas are those which are often found in forested habitats and are foliage gleaners (Cusa, Jackson and Mesure, 2015). This would suggest that birds are drawn to areas with higher vegetation, and supports the hypothesis that bird collisions rise with increased numbers of birds present in the area.

“Migrant traps” are areas with particularly high numbers of fatalities, characterized by certain conditions. Trees over five metres, high ground cover and large areas of glass create particularly deadly conditions. Klem et al. (2009) studied the vegetation directly adjacent to buildings in Manhattan, and found that a ten percent increase in tree height, and ten percent increase in the height of vegetation corresponded to a 30% and 13% increase in collisions in the fall migratory season.

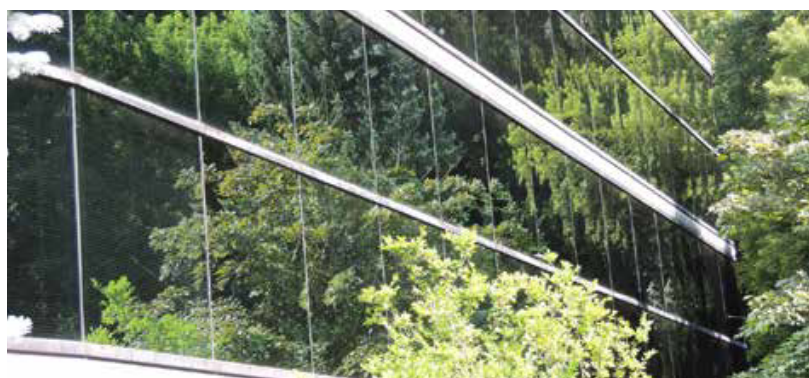
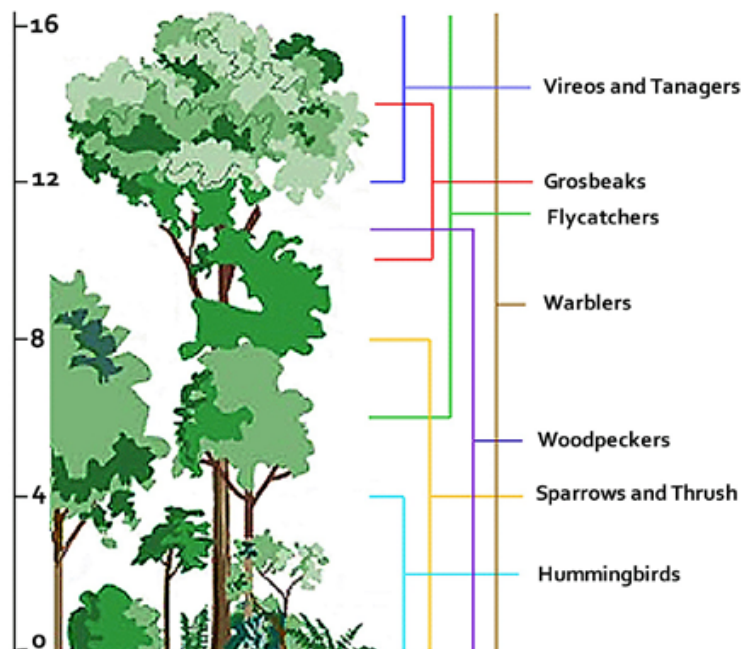

Vegetation and reflective windows create a hazardous environment for birds.

Image and Photos: FLAP Canada

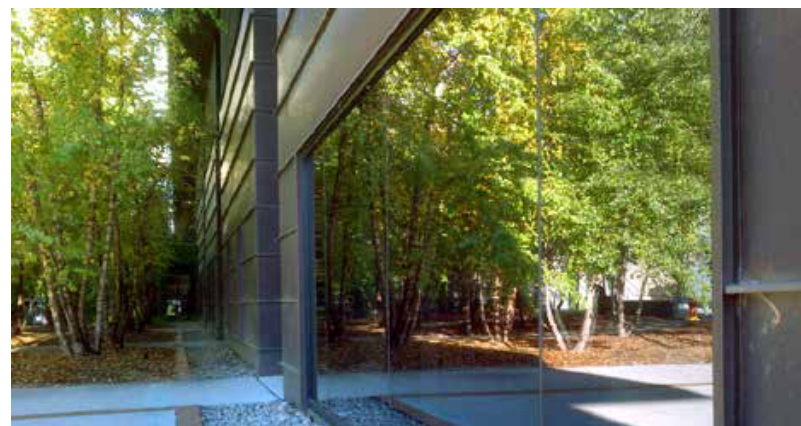

# References

Cusa M, Jackson DA, and Mesure M (2015). Window collisions by migratory bird species: urban geographical patterns and habitat associations. *Urban Ecosystems* 18:1

Evans Ogden, LJ (2002). Summary Report on the Bird-Friendly Building Program: Effect of Light Reduction on Collision of Migratory Birds. Special Report for the Fatal Light Awareness Program (FLAP). [online] URL: <http://digitalcommons.unl.edu/flap/5/>

Evans Ogden, LJ (1996). Collision course: the hazards of lighted structures and windows to migrating birds. Special report prepared for World Wildlife Fund and the Fatal Light Awareness program. WWF, Toronto, Ontario, Canada. [online] URL: <http://www.flap.org/pdfs/ccourse.pdf>

Klem D, Farmer CJ, Delacretaz N, Gelb Y, Saenger P (2009). Architectural and landscape risk factors associated with bird-glass collisions in an urban environment. *Wilson J Ornithol* 121:126–134

Klem D. Jr. (1990). Collisions between birds and windows: mortality and prevention. *Journal of Field Ornithology* 61:120-128

Kranjc, S. (2016, February 8). [email]. FLAP Canada. Toronto.

Machtans CS, Wedeles CHR, Bayne EM (2013). A first estimate for Canada of the number of birds killed by colliding with building windows. *Avian Conserv Ecol* 8:6

Wedeles, C., and D. Pickard. (2015). Scavenging and Searcher Efficiency Rates of Birds Killed by Collisions with Buildings in Downtown Toronto. Unpublished draft report prepared for Environment Canada. 53 p.

What Happens To All the Dead Birds Salvaged by FLAP? (2016). Retrieved from <http://www.flap.org/museum-program.php>



Photo: Tim Hoeflich via flickr

Bird-friendly

Mitigation

Compliance

Best practices



PLANNING A GREAT CITY  
**TOGETHER**



@CityPlanTO



[www.toronto.ca/planning](http://www.toronto.ca/planning)